

JBR-3266 Trimming Potentiometers

FEATURES

- Multiturn/ Cermet / Industrial/ Sealed, 5 Terminal Styles

Common Dimensions JBR-3266

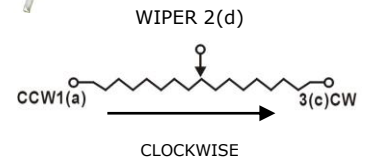
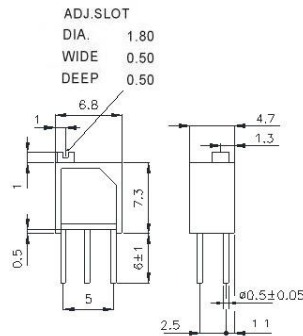

Tolerance is ± 0.25 if no identification

Electrical Characteristics	
Standard Resistance Range	10 Ω - 5M Ω
Resistance Tolerance	$\pm 10\%$; $\pm 20\%$ for 10, 20 and 2M ohm
Absolute Minimum Resistance	$\leq 10\Omega$ ($100\Omega \leq R \leq 1K\Omega$) $\leq 1\%R$ ($R > 1K\Omega$)
Contact Resistance Variation	CRV $\leq 3\%$ or 5 Ω (whichever is larger)
Insulation Resistance	$R1 \geq 1G\Omega$ (500Vdc)
Withstand Voltage	500VAC
Effective Travel	10 ± 2 turns nom

Environmental Characteristics	
Power Rating (300V max)	0.25W@70 $^{\circ}C$, 0W@125 $^{\circ}C$
Temperature Range	-55 $^{\circ}C$ ~ +125 $^{\circ}C$
Temperature Coefficient	$\pm 250 \times 10^{-6}/^{\circ}C$ ($\pm 100ppm/^{\circ}C$ on request)
Temperature Variation	-55 $^{\circ}C$, 30min, +125 $^{\circ}C$ 30min, 5 cycles $\Delta R \leq \pm 2\%R$, $\Delta(Uab/Uac) \leq \pm 2\%R$
Vibration	10 - 500Hz, 0.75mm, 6h $\Delta R \leq \pm 1\%R$, $\Delta(Uab/Uac) \leq \pm 2\%R$
Collision	390m/s ² , 4000cycles, $\Delta R \leq \pm 1\%R$
Electrical Endurance at 70 $^{\circ}C$	0.25W@70 $^{\circ}C$ 1000h, $\Delta R \leq \pm (5\%R + 0.1 \Omega)$, CRV $\leq \pm 3\%R$ or 5 Ω (whichever is larger)
Rotational Life	200 cycles $\Delta R \leq \pm (10\%R + 0.5 \Omega)$, CRV $\leq \pm 3\%R$ or 5 Ω

Physical Characteristics	
Starting Torque	$\leq 35mN \cdot m$
Marking	Resistance Tolerance (When no identification, it is of $\pm 10\%$) Resistance Code, Model
Standard Packaging	50pcs, per tube

JBR-3266W

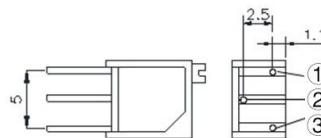

JBR-3266Y

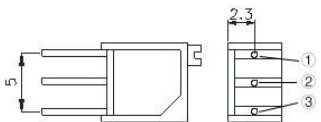

JBR-3266P

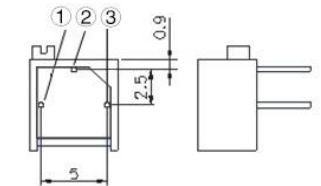

JBR-3266X

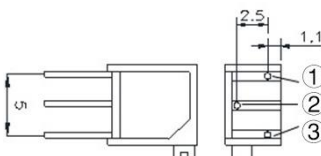

JBR-3266Z

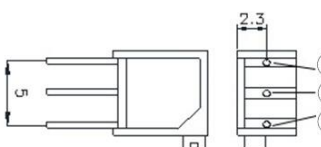

Resistance Table

Resistance (Ohms)	Resistance Code
10	100
20	200
50	500
100	101
150	151
200	201
250	251
300	301
470	471
500	501
680	681
1,000	102
1,500	152
2,000	202
2,200	222
2,500	252
3,000	302
4,700	472
5,000	502
6,800	682
10,000	103
15,000	153
20,000	203
22,000	223
25,000	253
30,000	303
33,000	333
47,000	473
50,000	503
68,000	683
100,000	104
150,000	154
200,000	204
220,000	224
250,000	254
300,000	304
330,000	334
470,000	474
500,000	504
680,000	684
1,000,000	105
2,000,000	205
2,200,000	225
5,000,000	505

Special resistances available

How to Order

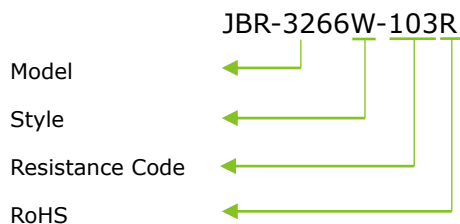

Please visit our website to get more update data, those data & specification are subject to change without notice.